

North American DV-10A Bronco

En semiskala Parkflyer opbygget i Depron og motoriseret med 2 stk. Speed 280 med Günther propeller

Konstruktion: Michael Hammer E-mail: Hammer.Models@gmail.com

Spændevide: 80cm

Hvor andet ikke er nævnt benyttes 5 mm Depron

Skala: 1:2

Hood fremstilles ved at trække opvarmet plastic omkring træmodel. Kan eventuelt laves i skum

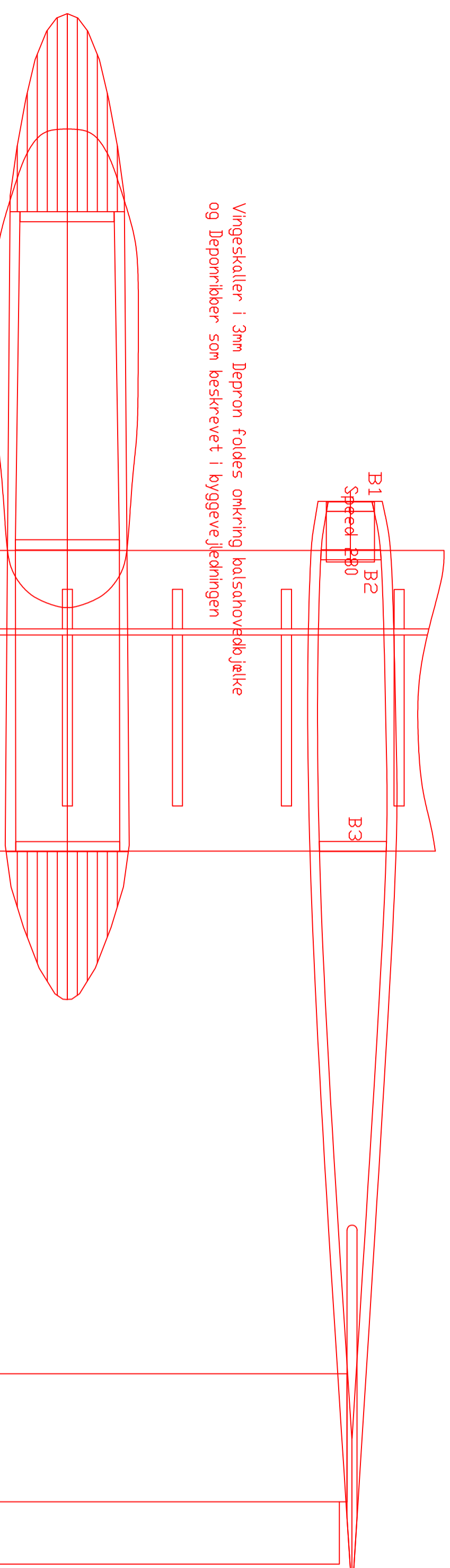
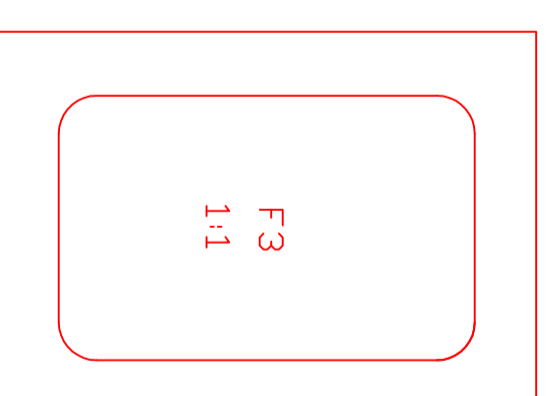
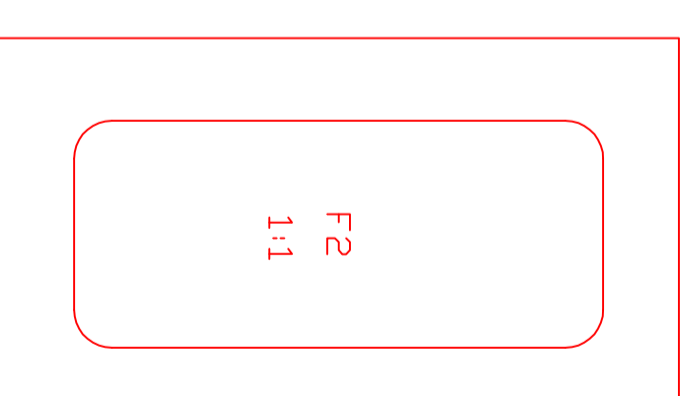
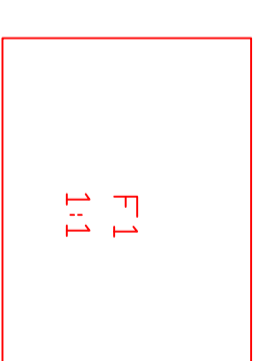
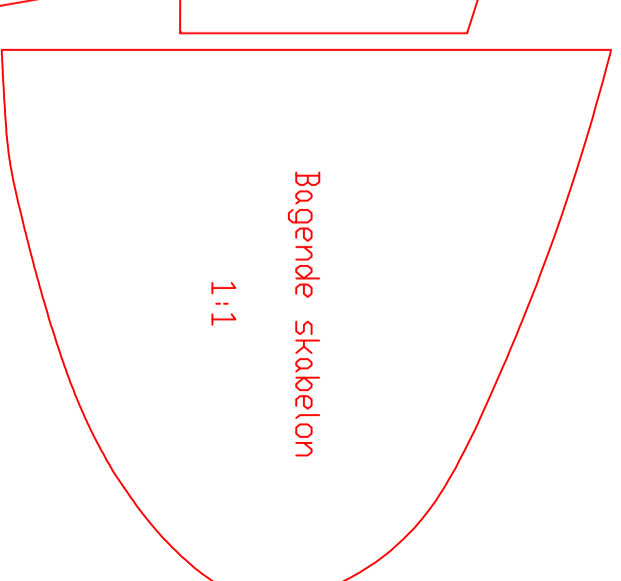
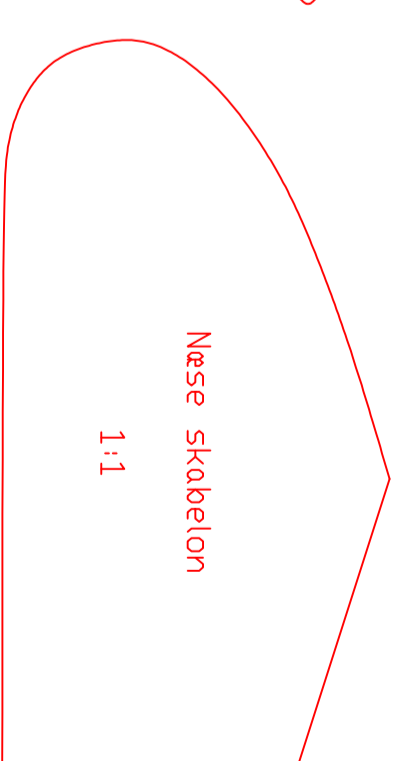
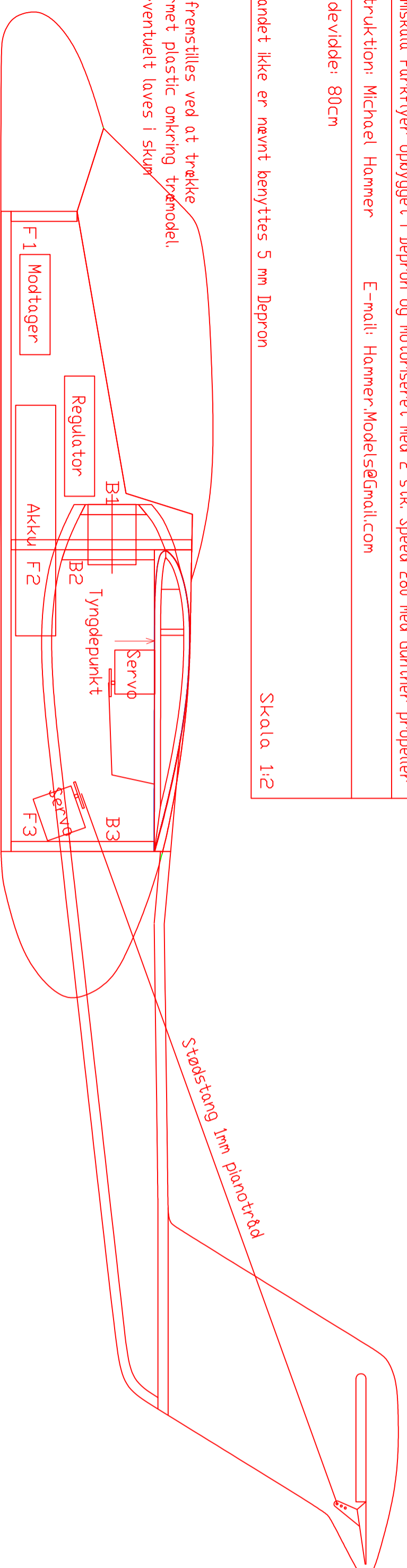

Side, krop 25stk.
1:1

Bund
1:1

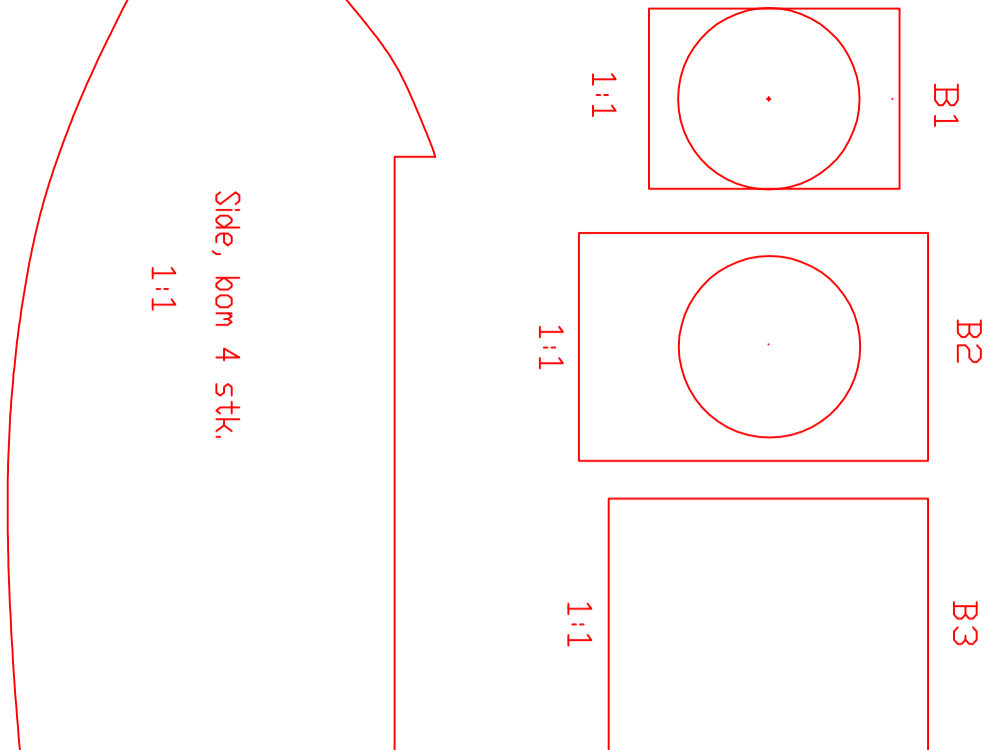

Side, bom 4 stk.
1:1

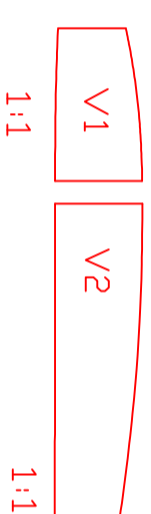
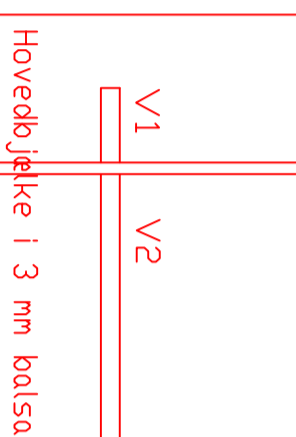

Finne, 25stk.
1:1

